



DEPARTAMENTO DE ORIENTACIÓN Y  
PSICOEDUCACIÓN

# FICHAS DE ATENCIÓN PARA NIÑOS DE 6 A 9 AÑOS



*SAN PEDRO DE LA PAZ, MARZO 2020*

Busca las palabras en la  
sopa de letras.

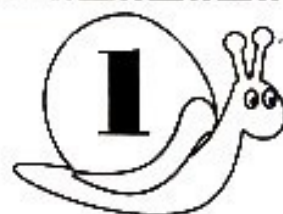

CERCA  
DEBAJO  
ENCIMA  
GRANDE

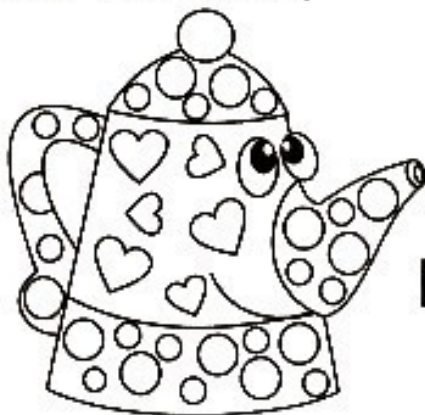

LEJOS  
LISTO  
PEQUEÑO  
TORPE

O	J	V	O	A	E	C	N	K	Q	A
C	T	Y	K	P	L	E	J	O	S	C
P	Y	S	R	R	W	W	D	O	E	R
V	L	O	I	O	G	W	J	N	M	E
D	T	J	K	L	A	R	C	X	O	C
C	E	W	U	A	P	I	A	Ñ	Y	Q
P	U	B	M	M	M	C	E	N	Z	I
Q	R	L	A	A	R	U	Q	T	D	D
M	Z	A	I	J	Q	P	S	Y	B	E
C	C	I	A	E	O	Z	M	Z	T	D
Z	M	B	P	Z	Z	E	B	T	L	U



¿Cuál de estos objetos se repite más veces?

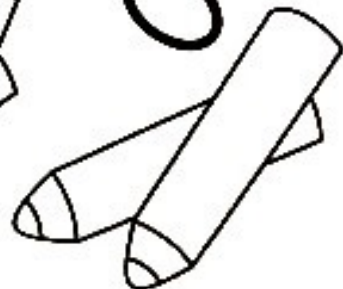
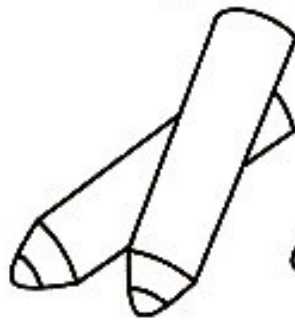
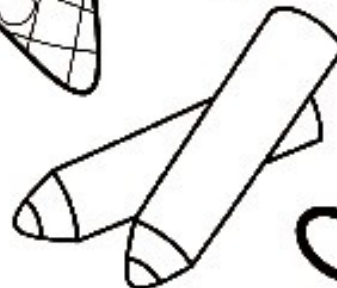
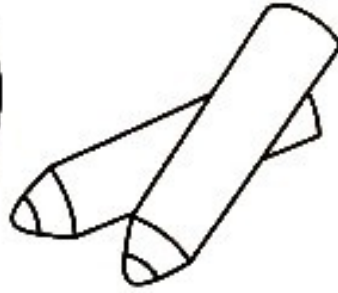

Busca las palabras en la  
sopa de letras.



P	Y	H	D	F	N	E	Y
A	C	W	H	V	G	X	P
N	P	R	S	Q	S	A	D
D	Y	S	Y	K	O	R	U
E	D	A	A	T	L	R	D
R	I	L	T	O	L	A	T
E	L	E	R	N	I	T	A
T	O	U	O	A	T	I	M
A	H	Ñ	M	I	A	U	B
F	A	A	P	P	L	G	O
C	T	T	E	B	P	T	R
C	U	S	T	E	Q	O	C
L	A	A	A	I	B	Q	D
Z	L	C	U	A	S	D	P
D	F	P	N	H	N	W	Z

CASTAÑUELAS

FLAUTA

GUITARRA

PANDERETA

PIANO

PLATILLOS

TAMBOR

TROMPETA





Ayuda al fantasma a encontrar el castillo.

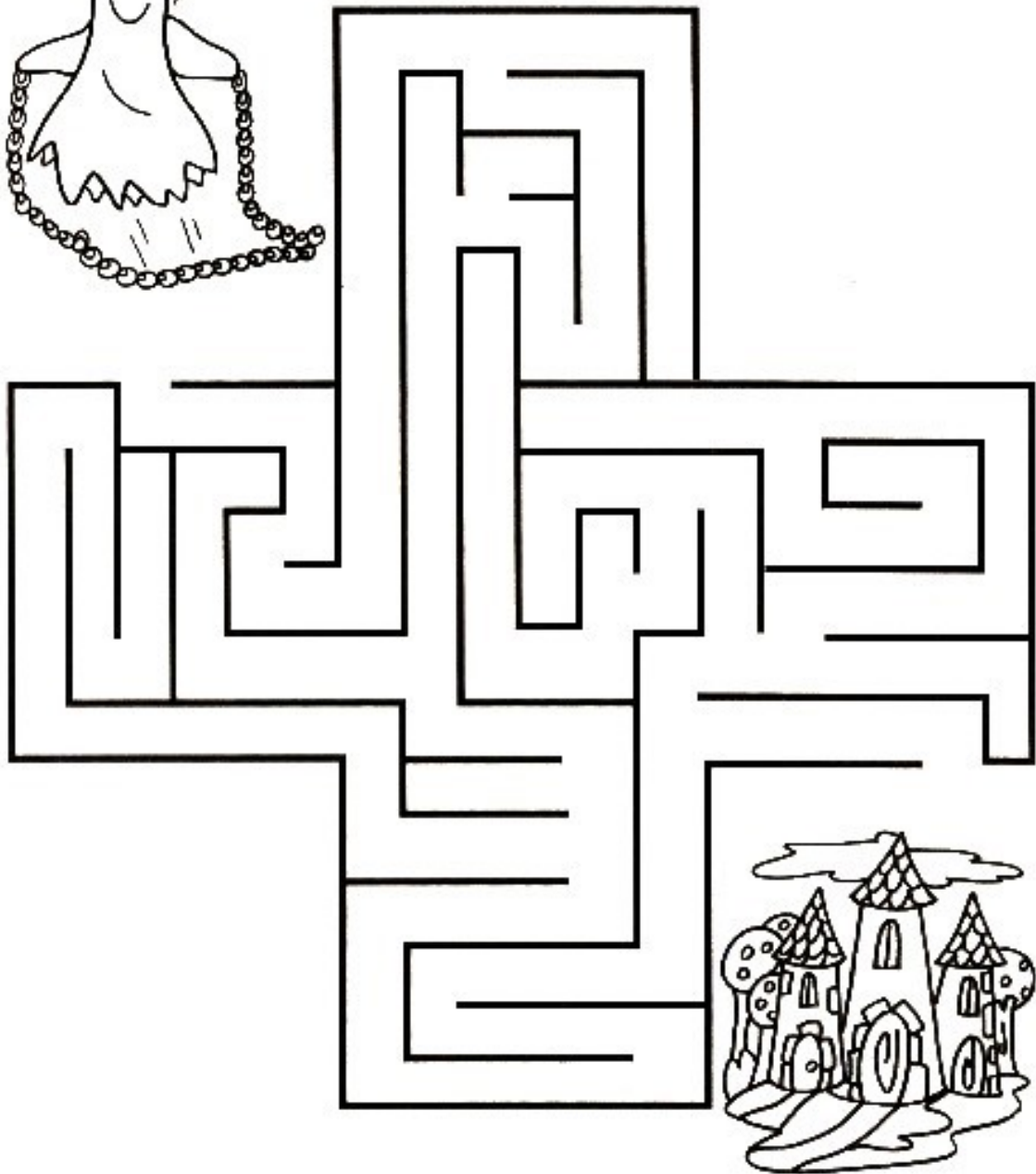

Coloca en la cruzada  
las palabras de la lista.



2 LETRAS

AL

CH

3 LETRAS

DAR

EPA

LLA

PIE

SAL

5 LETRAS

LICEO

OSADA

6 LETRAS

FIELTE

OCULAR

7 LETRAS

FELPUDO

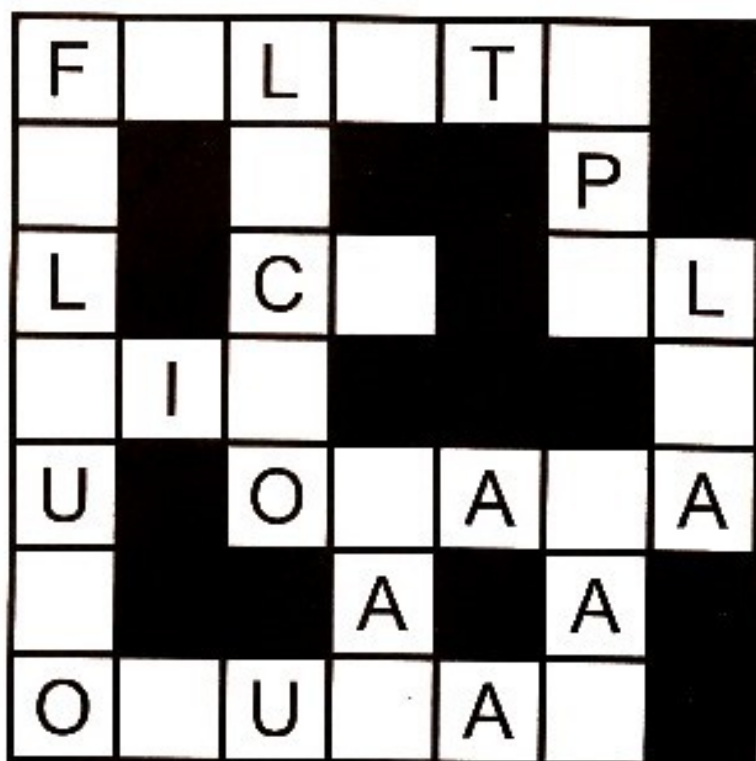
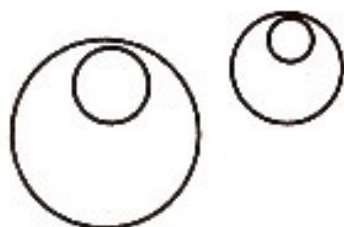
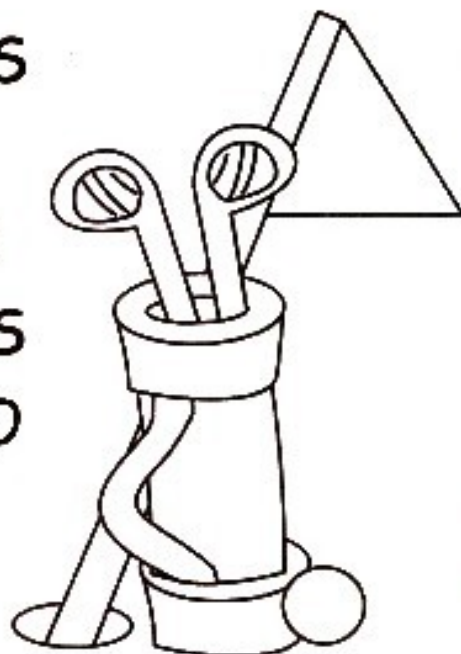

¿Cuál de estos dibujos es diferente a los demás?

37



A

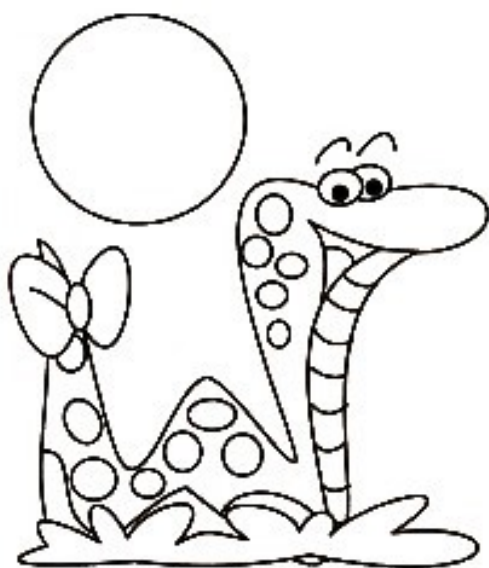

B

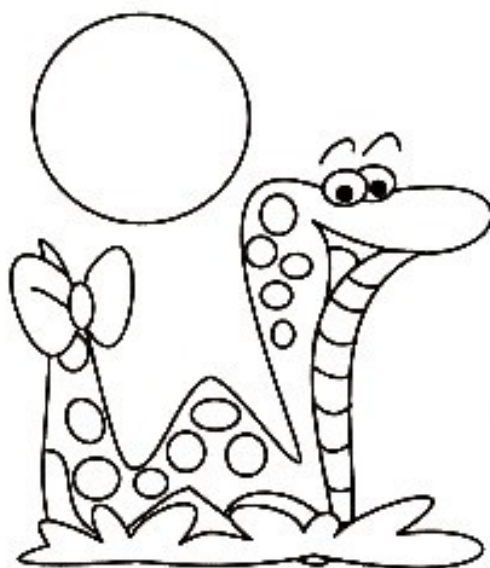

C

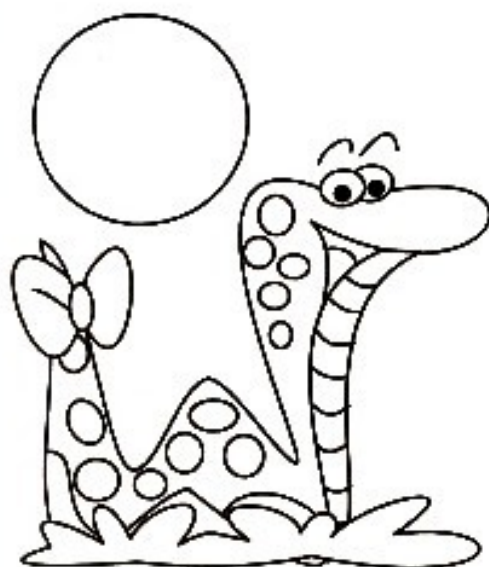

D

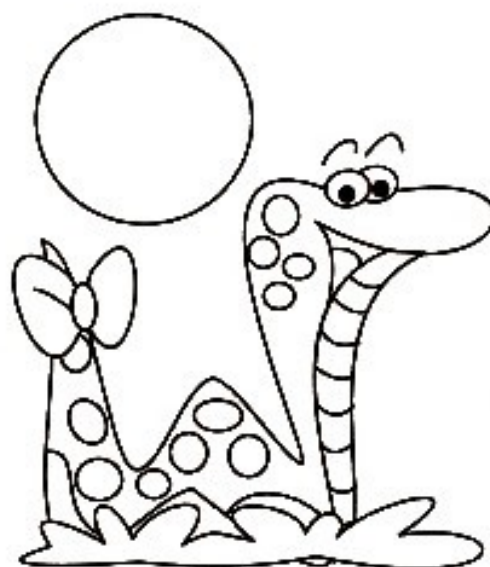



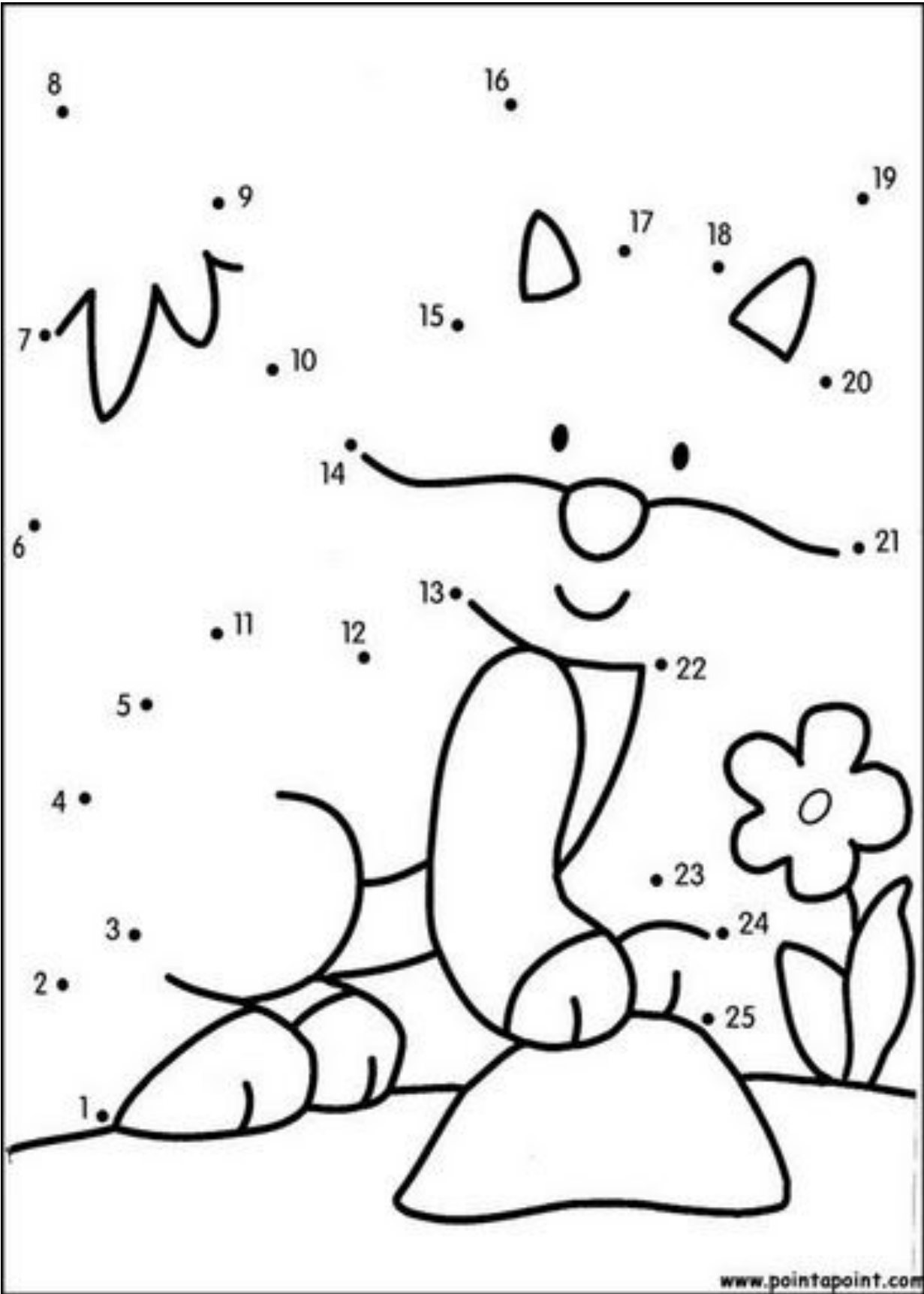

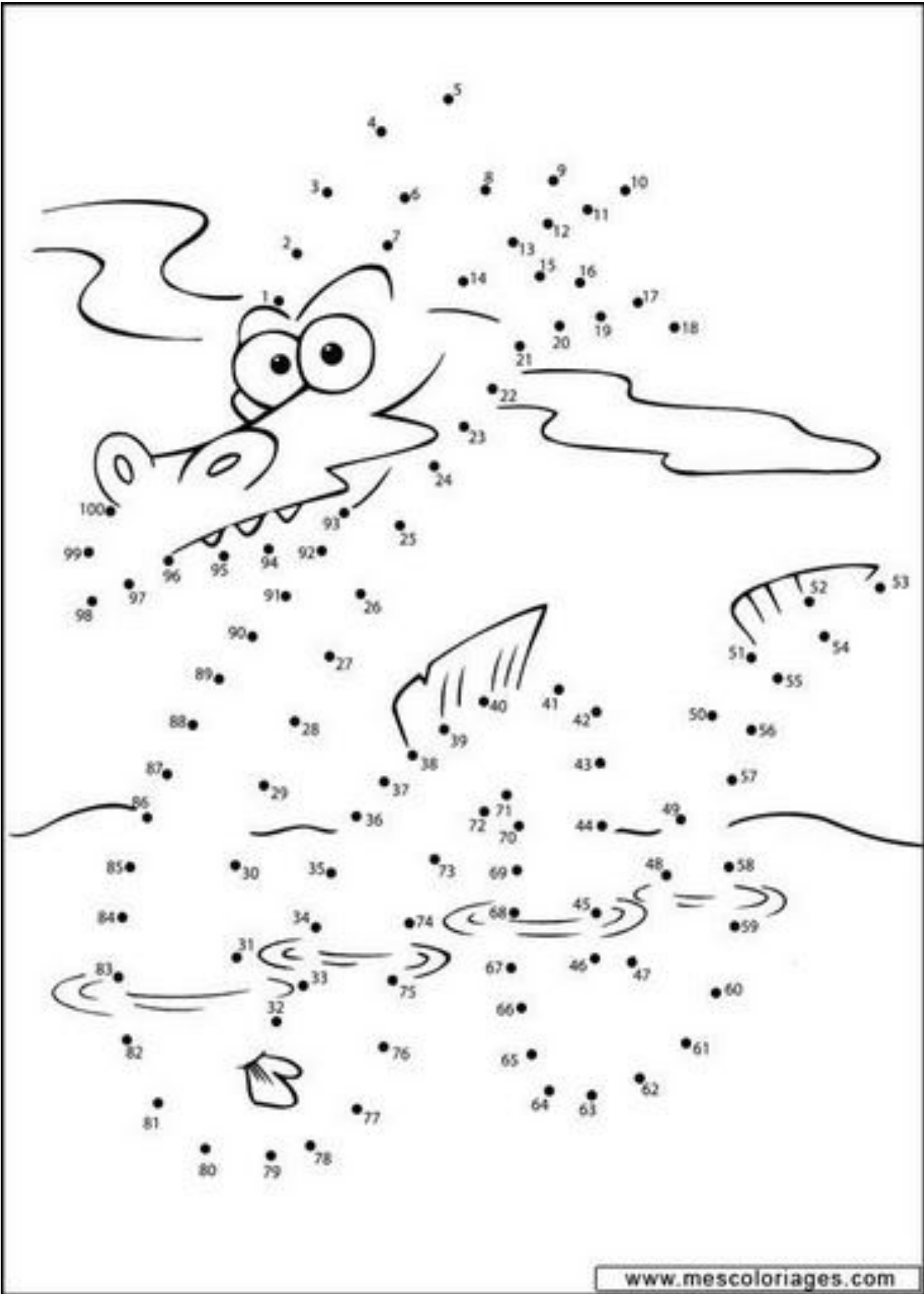



40

Busca las palabras en la  
sopa de letras.

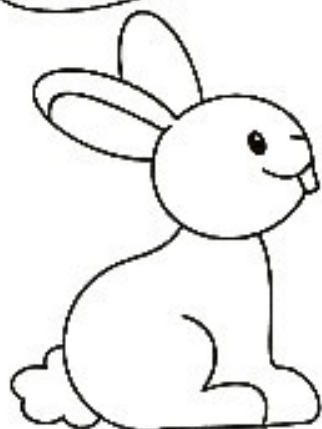

CERDO

PATO

CONEJO

PAVO

GALLINA

POLLO

OVEJA

VACA

A	C	A	V	D	C	K	C
O	Y	W	L	O	B	A	E
V	S	M	N	Z	N	K	R
A	O	E	P	I	P	O	D
P	J	V	L	O	T	U	O
O	W	L	E	A	L	P	E
O	A	Q	P	J	T	L	W
G	J	Q	I	T	A	E	O



Ayuda a la cocinera  
a encontrar su  
cocina.

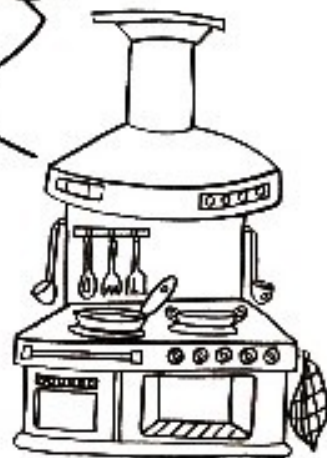
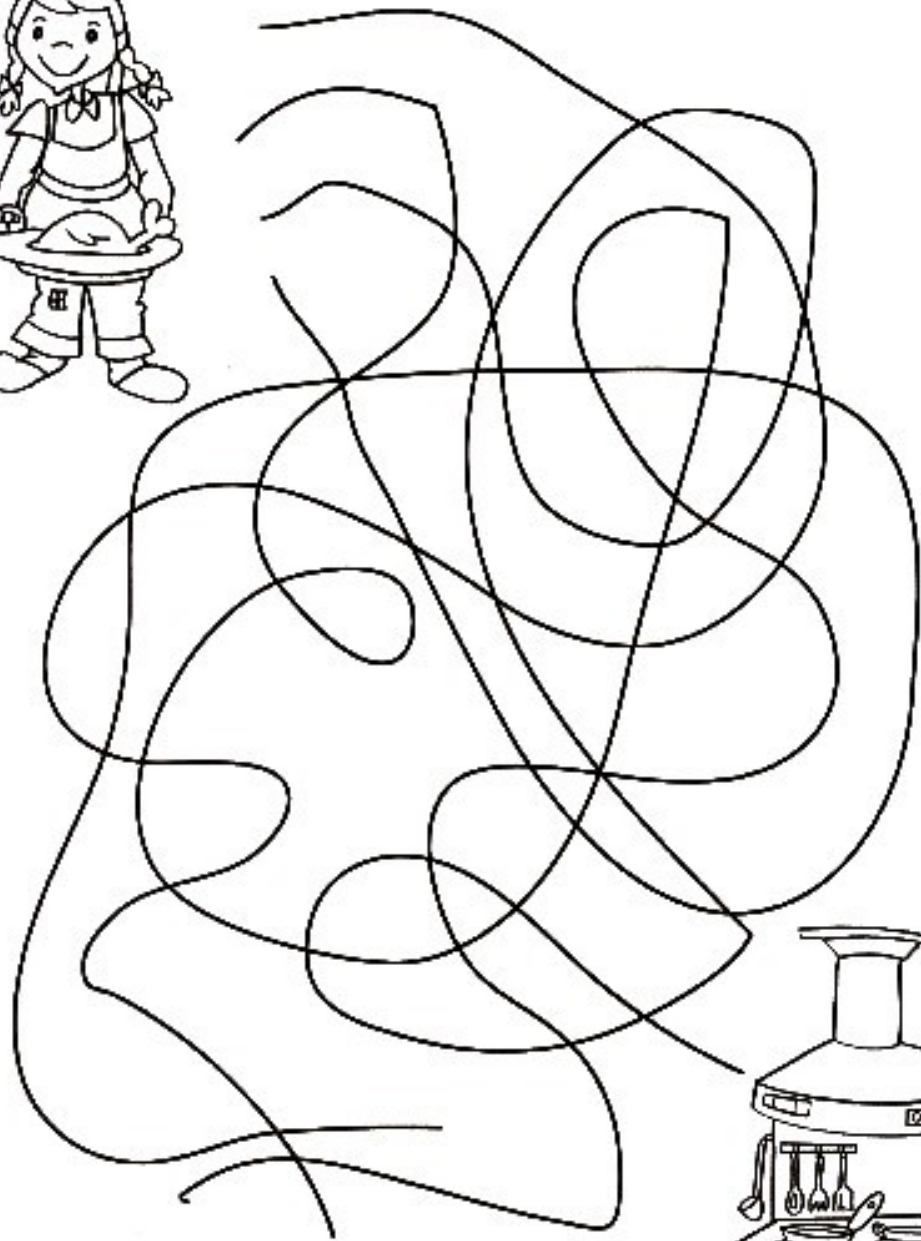

Busca las palabras en la  
sopa de letras.

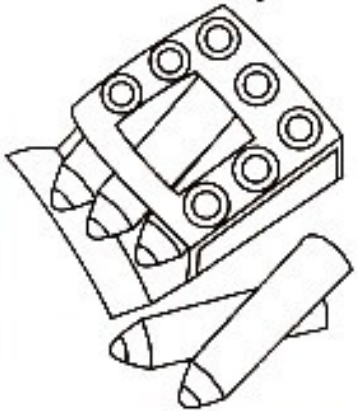

BOLÍGRAFO    LAPICERO  
CERA            LIBRO  
CUADERNO    PINTURA  
GOMA          SACAPUNTAS

O	F	A	R	G	I	L	O	B	S
N	P	I	N	T	U	R	A	A	F
C	W	U	G	A	Z	U	C	O	B
A	U	P	N	S	R	A	B	R	T
R	S	A	Y	U	P	G	N	E	I
E	R	G	D	U	T	O	J	C	L
C	W	D	N	E	R	Q	G	I	W
A	X	T	O	B	R	O	Q	P	W
U	A	W	I	H	M	N	I	A	R
S	C	L	F	A	F	U	O	L	A

Busca 5 diferencias  
entre estos dos dibujos.

27

